

M12 male 0° / M12 female 90° shielded

PUR 5x0.34 shielded gy 1m

Male straight – female 90°

M12 – M12, 5-pole
shielded

Plastic housings with good resistance against chemicals and oils.

The resistance to aggressive media should be individually tested for your application. Further details on request.

Further cable lengths on request.

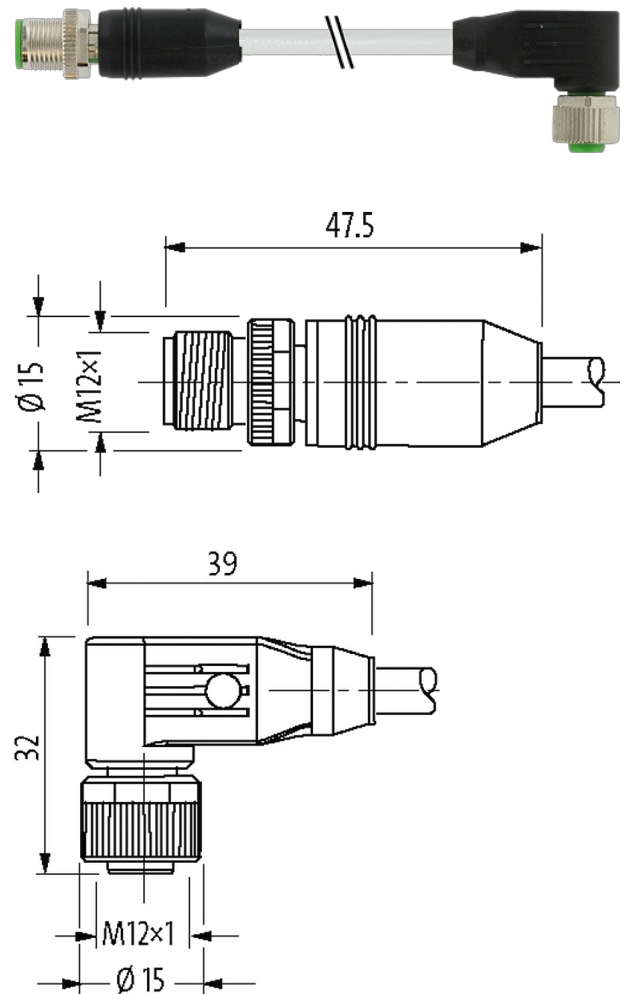
Illustration

Product may differ from Image

Approvals

* only for products with UL/CSA approved cable

EAC

Form

Form

40541

Cables

Cable number	349
No./diameter of wires	5× 0.34 mm ²
Wire isolation	PVC (br, wh, bl, bk, gnye)
C-track properties	0.1 Mio.
Jacket Color	gray
Material (jacket)	PUR/PVC
Outer Ø	5.9 mm ±5%
Bend radius (fixed)	10× outer Ø
Bend radius (moving)	15× outer Ø
Temperature range (fixed)	-40...+80 °C
Temperature range (mobile)	-5...+70 °C
Shield	yes
Color (jacket)	gray
Approval (cable)	CE conform

Technical Data

Operating voltage	max. 60 V AC/DC
Operating voltage (only UL listed)	max. 30 V AC/DC
Rated surge voltage	1.5 kV
Operating current per contact	max. 4 A
Material group	IEC 60664-1, category I
Coding	A-coded
Locking of ports	Screw thread (M12×1 mm) recommended torque 0.6 Nm, self-securing
Compression gland	M12 (SW13)
Protection	IP65 and IP67 when plugged and screwed down (EN 60529)
Locking material	Zinc die casting, matte nickel plated
Material	PUR
suitable for corrugated tube (internal Ø)	without

General data

Pollution Degree	3
Temperature range	-25...+85 °C, depending on cable quality
Material (gasket)	FKM

Commercial data

country of origin	CZ
customs tariff number	85444290
EAN	4048879164733
eClass	27279218
Packaging unit	1

Sketch

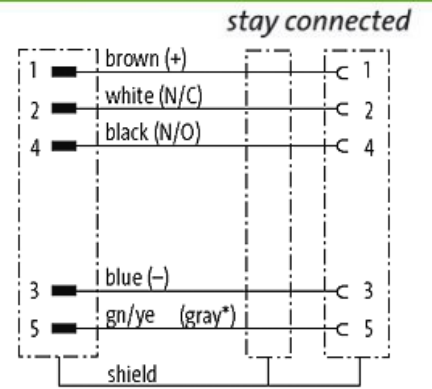

(* for cable type 203, 603, 243, 643)

Male

Female

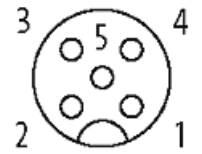
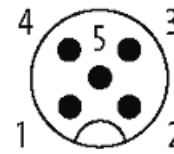

Product may differ from Image